

Model Name	JL-R-AE-100*61						전압옵션	LED	
Color Option	IR	RD	SW	NW	GR	BL	UV	12V / 24V	120
Watt		4.8W	9.6W						

4-M3TAP DP5
P.C.D ϕ 80

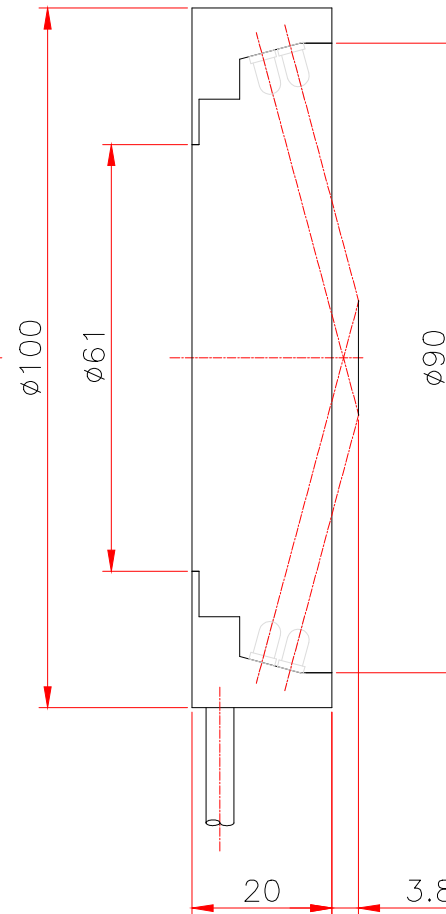

PIN MAP

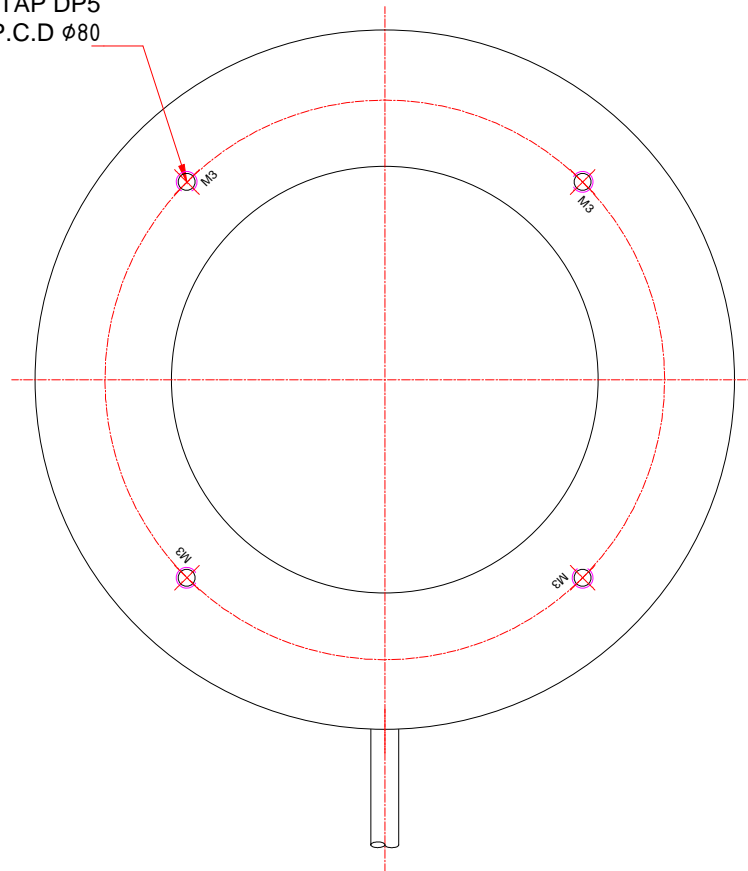

1: +
2: -

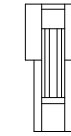

12V

JST Connector
SMR-02V-B



1: +
2: NC
3: -

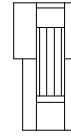

24V

JST Connector
SMR-03V-B